



# Asian

## 2007 亞洲射箭大獎賽第二站台北站 暨第二屆亞洲青年射箭錦標賽

## 2007 2<sup>nd</sup> Asian Archery Grand Prix & 2<sup>nd</sup> Asian Junior Archery Championships

日期：2007年6月14日至20日 · 14th~20th June 2007

主辦單位：亞洲射箭總會

Asian Archery Federation

指導單位：行政院體育委員會

Sports Affairs Council, Executive Yuan

教育部

Ministry of Education

中華奧林匹克委員會

Chinese Taipei Olympic Committee

中華民國體育運動總會

Republic of China Sports Federation

承辦單位：中華台北射箭協會

Chinese Taipei Archery Association

協辦單位：國立體育學院

National College of Physical Education and Sports

龜山鄉公所

Taoyuan Gueishan Township Office



HOLA  
和樂家居



POCARI  
SWEAT



華夏大飯店  
HIGHNESS HOTEL

# 2007 2nd Asian Grand Prix 亞洲大獎賽

## Recurve Men

ID No.	Country	Name	Target No.	Round 1 70 M	Rank	Round 2 70M	Rank	Total	10	X"	Rank
50014	KOR	Hee Jae Park	4B	335	4	344	1	679	39	15	1
50016	TPE	Cheng Pang Wang	6B	341	2	334	2	675	40	16	2
50015	TPE	Cheng Wei Kuo	5B	341	1	331	6	672	33	9	3
50013	KOR	Si Hyeon Jang	3B	330	8	334	3	664	31	8	4
50012	KOR	Jaek Ahn	2B	330	7	334	4	664	30	4	5
50011	KOR	Jong Geon Kim	1B	327	11	333	5	660	31	10	6
50017	TPE	Ming Huang Liu	7B	338	3	321	13	659	29	10	7
50019	TPE	Szu Yuan Chen	9B	332	5	325	8	657	26	3	8
50028	AUS	Cuddihy Timothy	6C	330	9	324	9	654	22	2	9
50027	AUS	Ha Neul Kim	5C	325	13	323	10	648	27	8	10
50018	TPE	Chih Lung Yu	8B	324	15	322	12	646	23	4	11
50022	INA	Mohammad Ali Sofian	12A	323	16	323	11	646	15	4	12
50031	SIN	Loh Wen Liang, Albert	9C	324	14	321	14	645	25	7	13
50004	JPN	Banno Taichi	4A	318	20	327	7	645	23	7	14
50020	TPE	Tzu Yi Hsu	10B	327	12	316	18	643	21	3	15
50001	THA	THEPNA DENCHAI	1A	327	10	315	19	642	22	8	16
50007	JPN	Oshima Jun	7A	321	18	321	14	642	16	5	17
50030	AUS	Cheah Ricci	8C	319	19	318	17	637	15	5	18
50006	JPN	Minoda Akihiro	6A	331	6	304	24	635	25	6	19
50005	JPN	Usui Tatsuro	5A	315	21	315	20	630	16	5	20

Judge Andy Wu

Competition Dir. Wen Sheng-shien

Scoring Dir. [Signature]

50029	AUS	Tyack Ryan	7C	308	24	319	16	627	15	4	21
50002	THA	Thiangprasert Jarun	2A	322	17	297	29	619	13	4	22
50021	INA	Hendro Suprianto	11A	312	22	302	26	614	14	1	23
50023	HKG	Chan Kam Shing	1C	305	27	309	21	614	12	1	24
50024	HKG	Lee Kar Wai	2C	309	23	302	25	611	13	3	25
50008	VIE	Nguyen Ba Hai	8A	308	25	294	31	602	10	0	26
50032	SIN	Ong Chee Bin, Benson	10C	293	29	306	22	599	19	0	27
50025	HKG	Suen Tse Hin	3C	292	30	305	23	597	10	4	28
50010	VIE	Nguyen Trong Nghiep	10A	292	31	298	28	590	10	0	29
50003	THA	Inkaew Sakon	3A	289	32	299	27	588	13	4	30
50026	HKG	Yip Sai Kit	4C	305	26	280	34	585	11	1	31
50034	SIN	Ong Chee Tiong, Henry	12B	295	28	288	32	583	10	4	32
50009	VIE	Pham Ngoc Hai	9A	282	33	297	30	579	9	0	33
50033	SIN	Pang Toh Jin	11B	281	34	287	33	568	12	2	34

Judge Paul M. H. Competition Dir. Zum Sheng-chien Scoring Dir. [Signature]

# 2007 2<sup>nd</sup> Asian Prix Round

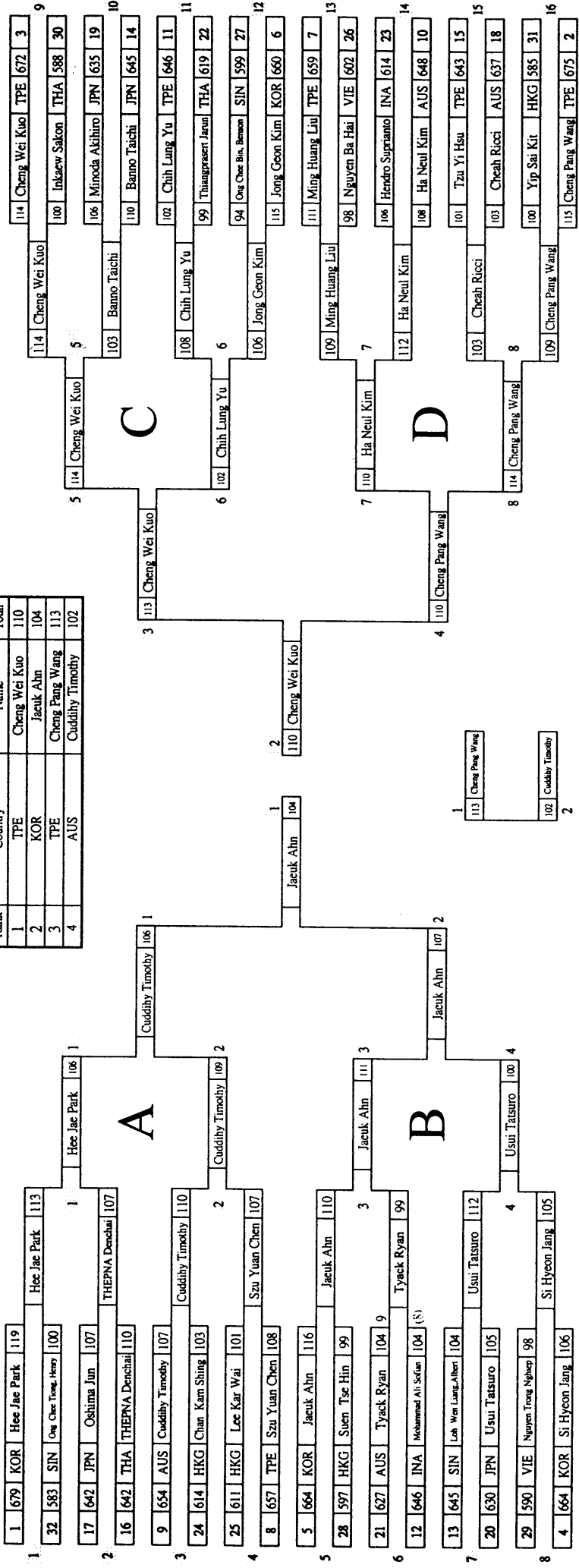

Recurve Men

Rank	Country	Name	Total
1	TPE	Cheng Wei Kuo	110
2	KOR	Jaeuk Ahn	104
3	TPE	Cheng Pang Wang	113
4	AUS	Cuddihy Timothy	102

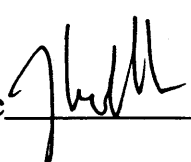
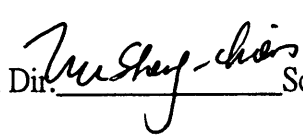

Judge: *[Signature]* Competition Dir: *[Signature]* Scoring Dir: *[Signature]*

2007 2nd Asian Grand Prix 亞洲大獎賽										
Group	Recurve Men		Qualification Round						Team Total	Team Rank
Target No.	Country	Name	70 M	70 M	Total	Rank				
6B	TPE	Cheng Pang Wang	341	334	675	2			2006	1
5B	TPE	Cheng Wei Kuo	341	331	672	3				
7B	TPE	Ming Huang Liu	338	321	659	7				
4B	KOR	Hee Jae Park	335	344	679	1			2003	2
3B	KOR	Si Hyeon Jang	330	334	664	4				
1B	KOR	Jong Geon Kim	327	333	660	6				
6C	AUS	Cuddihy Timothy	330	324	654	9			1929	3
5C	AUS	Ha Neul Kim	325	323	648	10				
7C	AUS	Tyack Ryan	308	319	627	21				
4A	JPN	Banno Taichi	318	327	645	14			1922	4
7A	JPN	Oshima Jun	321	321	642	17				
6A	JPN	Minoda Akihiro	331	304	635	19				
1A	THA	THEPNA Denchai	327	315	642	16			1849	5
2A	THA	Thiangprasert Jarun	322	297	619	22				
3A	THA	Inkaew Sakon	289	299	588	30				
9C	SIN	Loh Wen Liang, Albert	324	321	645	13			1812	6
10C	SIN	Ong Chee Bin, Benson	293	306	599	27				
11B	SIN	Pang Toh Jin	281	287	568	34				
1C	HKG	Chan Kam Shing	305	309	614	24			1810	7
2C	HKG	Lee Kar Wai	309	302	611	25				
4C	HKG	Yip Sai Kit	305	280	585	31				
8A	VIE	Nguyen Ba Hai	308	294	602	26			1771	8
10A	VIE	Nguyen Trong Nghiep	292	298	590	29				
9A	VIE	Pham Ngoc Hai	282	297	579	33				

Judge  Competition Dir.  Scoring Dir. 

# 2007 2nd Asian Prix Round

## Recurve Men

Target No.

Rank	Country	Name	Score
1	TPE	Cheng Pang Wang	223
		Cheng Wei Kuo	
		Ming Huang Liu	
2	KOR	Hee Jae Park	218
		Si Hyeon Jang	
3	THA	Jong Geon Kim	222
		THEPNA Danchai	
		Thiangprasert Jarun Inkaew Sakon	

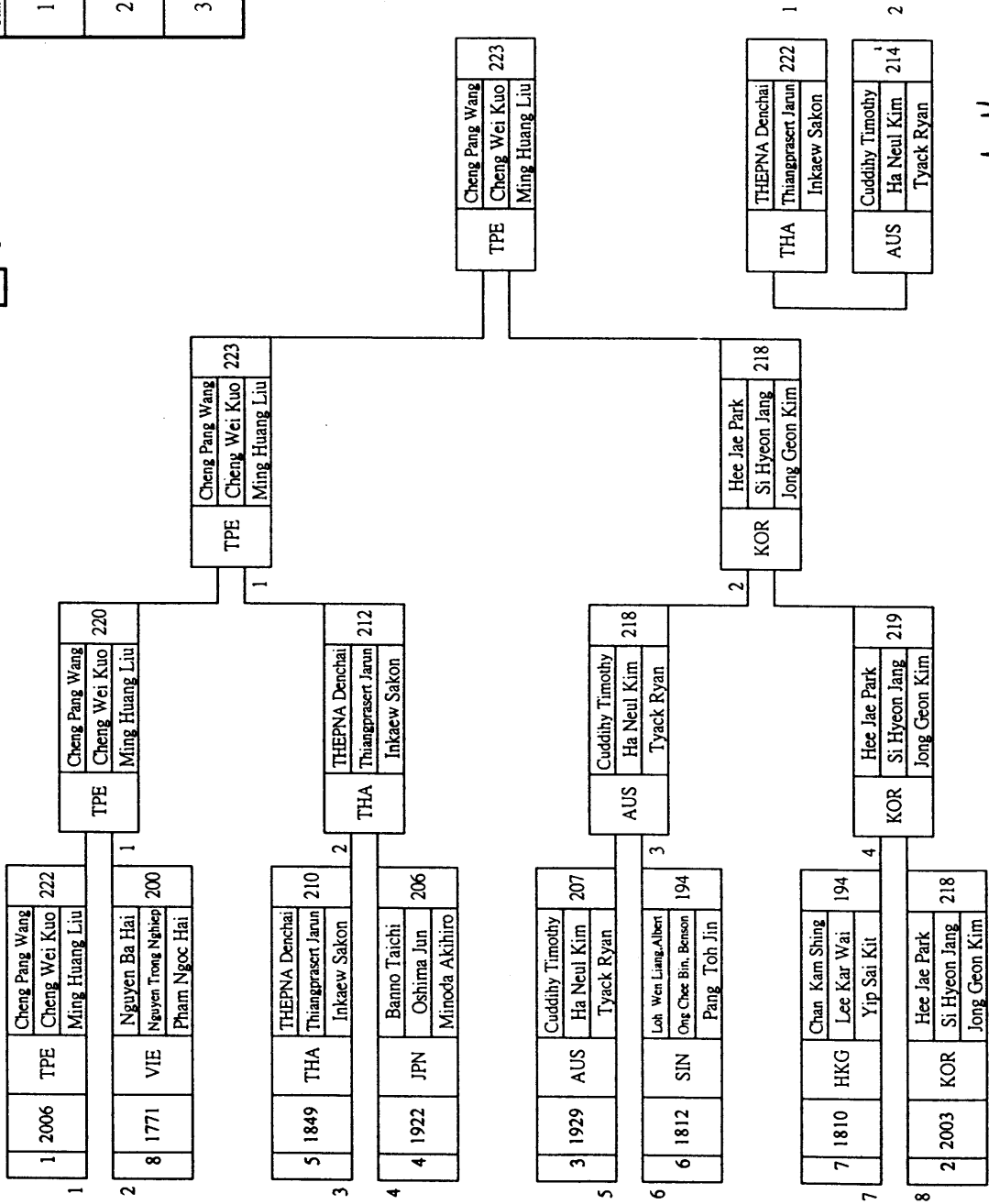

Judge:

Competition Dir:

Scoring Dir:

# 2007 2nd Asian Grand Prix 亞洲大獎賽

Recurve Women			Qualification Round					Elimination & Final Round				
Rank	ID No.	Country	Name	Round 1 70 M	Round 2 70M	Total	10 X"	[1/16]	[1/8]	[1/4]	[1/2]	[Final]
1	10020	TPE	Shen, Hsiao-Chun	329	332	661	30	8	0	109	110	107
2	10007	KOR	JUNG, JUIM	330	308	638	21	3	104	106	98	102
3	10019	TPE	Yuan, Shu-Chi	319	319	638	21	5	110	102	101	103
4	10004	JPN	OSHIMA-MEGUMI	306	294	600	14	4	104	107	96	101
5	10023	TPE	Tai, Jui- Hsien	316	318	634	14	5	104	107	105	
6	10003	JPN	OKI-SHIORI	324	308	632	24	6	94	107	98	
7	10018	TPE	Wu, Hui-Ju	322	319	641	17	6	0	104	98	
8	10011	INA	Yasmidar Hamid	311	305	616	15	5	96	101	88	
9	10001	JPN	ZUSHI-MIKIE	326	311	637	15	6	100	105		
10	10022	TPE	Pan, Ming-Chia	317	317	634	20	5	100	104		
11	10010	INA	SUCI DWI MEGASARI	311	306	617	11	5	102	103		
12	10008	KOR	Yu, Jae Eun	324	304	628	21	7	111	103		
13	10021	TPE	Tseng, Li-Wen	321	305	626	17	3	100	99		
14	10005	KOR	CHOI-MINA	326	327	653	26	7	0	98		
15	10024	SIN	Ling Boon Khing	292	286	578	6	1	95	95		
16	10006	KOR	KIM, MIN JONG	323	318	641	22	7	0	90		
17	10027	SIN	Shatricia Nair	253	231	484	6	1	99			
18	10015	VIE	Nguyen Thanh-Thuy	286	265	551	6	3	97			
19	10014	HKG	Kwok Yuk-Ying	275	267	542	10	2	96			
20	10002	JPN	HARIMA-MAKI	299	271	570	12	2	94			
21	10012	HKG	Lee Wai-Hong	290	277	567	12	4	92			
22	10017	VIE	Dinh Thi-Thu Trang	254	256	510	6	1	91			
23	10026	SIN	Ng Yuqin, Kimberly	285	231	516	3	2	90			
24	10013	HKG	Yeung Ying-Ying	264	234	498	5	0	89			
25	10009	AUS	WALTERS-JESSICA	293	269	562	10	4	88			
26	10028	SIN	Kuan Hui-Min	287	268	555	9	2	82			
27	10016	VIE	Nguyen Tra-My	264	262	526	7	4	80			
28	10025	SIN	Tan Ying Qi, Valerie	266	230	496	10	2	78			

# 2007 2nd Asian Grand Prix 亞洲大獎賽

## Recurve Women

ID No.	Country	Name	Target No.	Round 1 70 M	Rank	Round 2 70M	Rank	Total	10	X	Rank
10020	TPE	Shen, Hsiao-Chun	6B	329	2	332	1	661	30	8	1
10005	KOR	CHOI-MI NA	5A	326	4	327	2	653	26	7	2
10006	KOR	KIM, MIN JONG	6A	323	7	318	5	641	22	7	3
10018	TPE	Wu, Hui-Ju	4B	322	8	319	3	641	17	6	4
10019	TPE	Yuan, Shu-Chi	5B	319	10	319	4	638	21	5	5
10007	KOR	JUNG, JUIM	7A	330	1	308	10	638	21	3	6
10001	JPN	ZUSHI-MIKIE	1A	326	3	311	8	637	15	6	7
10022	TPE	Pan, Ming-Chia	8B	317	11	317	7	634	20	5	8
10023	TPE	Tai, Jui- Hsien	9B	316	12	318	6	634	14	5	9
10003	JPN	OKI-SHIORI	3A	324	6	308	9	632	24	6	10
10008	KOR	Yu, Jae Eun	8A	324	5	304	14	628	21	7	11
10021	TPE	Tseng, Li-Wen	7B	321	9	305	13	626	17	3	12
10010	INA	SUCI DWI MEGASARI	9A	311	13	306	11	617	11	5	13
10011	INA	Yasmidar Hamid	10A	311	13	305	12	616	15	5	14
10004	JPN	OSHIMA-MEGUMI	4A	306	15	294	15	600	14	4	15
10024	SIN	Ling Boon Khing	4C	292	18	286	16	578	6	1	16
10002	JPN	HARIMA-MAKI	2A	299	16	271	18	570	12	2	17
10012	HKG	Lee Wai-Hong	1C	290	19	277	17	567	12	4	18
10009	AUS	WALTERS-JESSICA	10B	293	17	269	19	562	10	4	19
10028	SIN	Kuan Hui-Min	8C	287	20	268	20	555	9	2	20
10015	VIE	Nguyen Thanh-Thuy	1B	286	21	265	22	551	6	3	21
10014	HKG	Kwok Yuk-Ying	3C	275	23	267	21	542	10	2	22
10016	VIE	Nguyen Tra-My	2B	264	25	262	23	526	7	4	23
10026	SIN	Ng Yuqin, Kimberly	6C	285	22	231	27	516	3	2	24
10017	VIE	Dinh Thi-Thu Trang	3B	254	27	256	24	510	6	1	25
10013	HKG	Yeung Ying-Ying	2C	264	26	234	25	498	5	0	26
10025	SIN	Tan Ying Qi, Valerie	5C	266	24	230	28	496	10	2	27
10027	SIN	Shatricia Nair	7C	253	28	231	26	484	6	1	28



Judge Julia Competition Dir. Aus Sheaf-Chiu Scoring Dir.



# 2007 2<sup>nd</sup> Asian Prix Round

Recurve Women

Rank	Country	Name	Total
1	TPE	Shen, Hsiao-Chun	107
2	KOR	JUNG, JUIM	102
3	TPE	Yuan, Shu-Chi	103
4	JPN	OSHIMA-MEGUMI	101

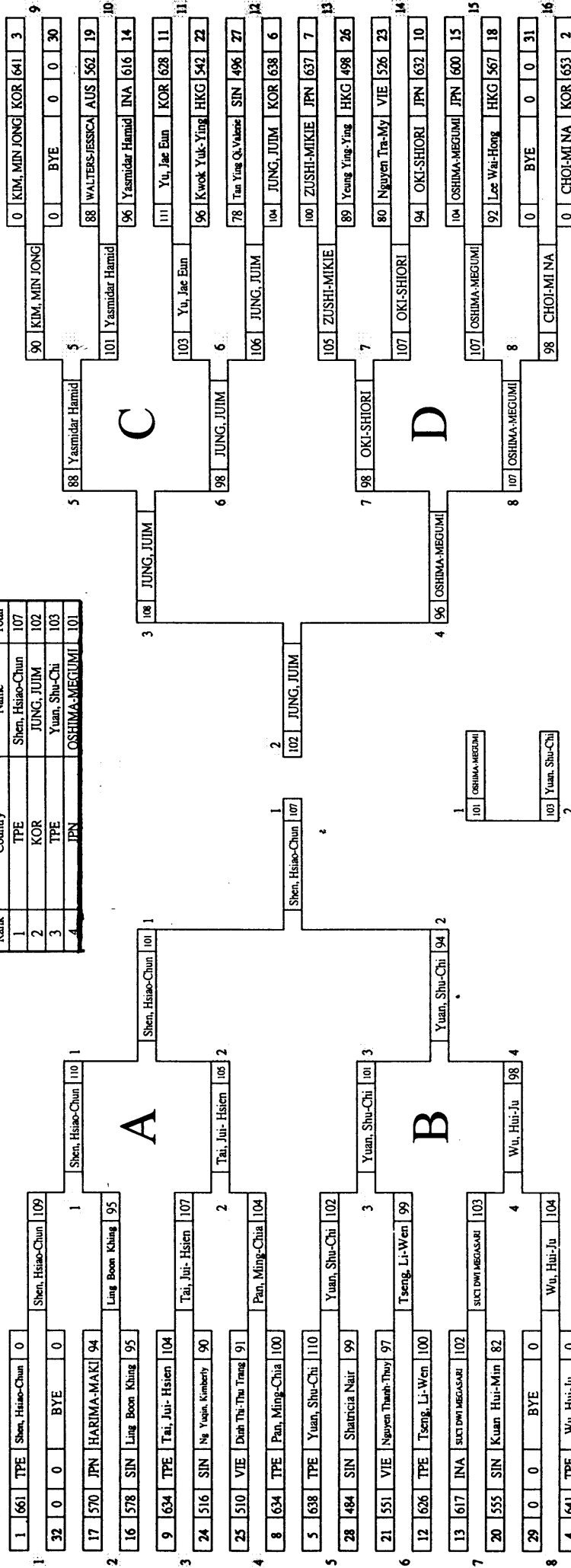

Judge: *Yuhui* Competition Dir: *Tao Slog-chio* Scoring Dir: *[Signature]*

2007 2nd Asian Grand Prix 亞洲大獎賽										
Group		Recurve Women		Qualification Round						
Target No.	Country	Name	70 M	70 M	Total	Rank			Team Total	Team Rank
6B	TPE	Shen, Hsiao-Chun	329	332	661	1			1940	1
4B	TPE	Wu, Hui-Ju	322	319	641	4				
5B	TPE	Yuan, Shu-Chi	319	319	638	5				
5A	KOR	CHOI-MI NA	326	327	653	2			1919	2
7A	KOR	JUNG, JUIM	330	308	638	6				
8A	KOR	Yu, Jae Eun	324	304	628	11				
1A	JPN	ZUSHI-MIKIE	326	311	637	7			1869	3
3A	JPN	OKI-SHIORI	324	308	632	10				
4A	JPN	OSHIMA-MEGUMI	306	294	600	15				
1C	HKG	Lee Wai-Hong	290	277	567	18			1607	4
3C	HKG	Kwok Yuk-Ying	275	267	542	22				
2C	HKG	Yeung Ying-Ying	264	234	498	26				
4C	SIN	Ling Boon Khing	292	286	578	16			1590	5
6C	SIN	Ng Yuqin, Kimberly	285	231	516	24				
5C	SIN	Tan Ying Qi, Valerie	266	230	496	27				
1B	VIE	Nguyen Thanh-Thuy	286	265	551	21			1587	6
2B	VIE	Nguyen Tra-My	264	262	526	23				
3B	VIE	Dinh Thi-Thu Trang	254	256	510	25				

Judge *[Signature]* Competition Dir. *[Signature]* Scoring Dir. *[Signature]*

# 2007 2nd Asian Prix Round

## Recurve Women

Rank	Country	Name	Score
1	TPE	Shen, Hsiao-Chun Wu, Hui-Ju Yuan, Shu-Chi	203
2	JPN	ZUSHI-MIKIE OKI-SHIORI OSHIMA-MEGUMI	185
3	KOR	CHOI-MI NA JUNG, JUIM Yu, Jae Eun	220

Target No.

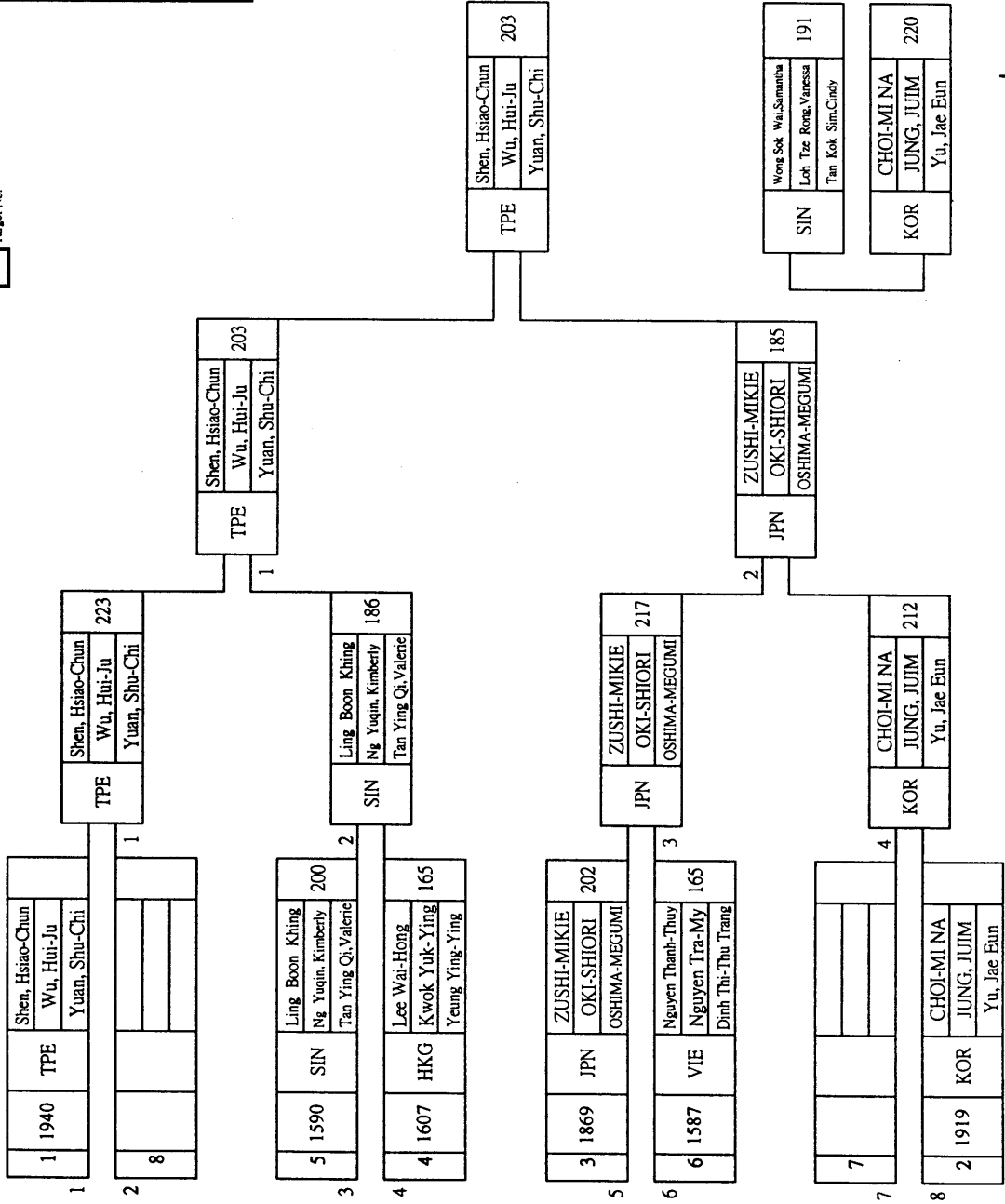

Judge: *[Signature]* Competition Dir. *[Signature]* Scoring Dir. *[Signature]*

# 2007 2nd Asian Grand Prix 亞洲大獎賽

Compound Men			Qualification Round							Elimination & Final Round				
			Rank	ID No.	Country	Name	Round 1 70 M	Round 2 70M	Total	10	X"	[1/16]	[1/8]	[1/4]
1	30003	SIN	Leow Ting Hao	346	335	681	38	12	0	114	108	114	109	
2	30010	TPE	Wen Shiang Wu	343	342	685	41	9	0	115	116	112	108	
3	30012	TPE	Chih Hao Wang	336	337	673	28	7	0	113	115	112	116	
4	30014	TPE	Chi Kun Liu	337	341	678	36	11	0	111	114	108	110	
5	30020	PHI	Earl Benjamin Yap	339	345	684	40	10	0	115	114			
6	30016	VIE	Nguyen Tien Cwng	332	329	661	27	9	108	115	113			
7	30001	SIN	Ong Chong Soon, Michael	336	333	669	27	9	111	110	109			
8	30005	INA	Gatot Ariyanto	331	332	663	27	8	107	109	107			
9	30007	THA	THONGWATTANA CHAKRIT	346	332	678	39	9	0	114				
10	30002	SIN	Heng Fook Hup, Vinson	330	324	654	24	7	111	113				
11	30009	THA	Fakkeaw Siripong	326	332	658	25	8	112	111				
12	30018	PHI	Enrique Cojuangco Jr	334	329	663	33	5	109	111				
13	30008	THA	Pannoi Arkhom	330	330	660	23	8	113	110				
14	30011	TPE	Yung Ming Tsou	333	329	662	27	7	109	110				
15	30004	SIN	Chua Boon Rong, Adriel	337	336	673	27	5	0	110				
16	30013	TPE	Sen Ching Lee	337	337	674	36	13	0	107				
17	30019	PHI	Rosendo Sombrio	330	316	646	20	1	109					
18	30006	INA	Wahyu Hidayat	317	326	643	20	7	107					
19	30024	HKG	Tai Hoi Bun	314	314	628	15	3	105					
20	30015	TPE	Chih Ting Hsu	325	325	650	23	9	104					
21	30017	VIE	Nguyen Thanh Tuan	321	302	623	18	6	103					
22	30021	PHI	Rosouro Timoko Bismark	301	297	598	10	4	103					
23	30023	HKG	ViSion Young	311	319	630	17	7	103					
24	30025	HKG	Liu Ching Chung	303	307	610	13	3	96					

# 2007 2nd Asian Grand Prix 亞洲大獎賽

## Compound Men

ID No.	Country	Name	Target No.	Round 1 70 M	Rank	Round 2 70M	Rank	Total	10	X	Rank
30010	TPE	Wen Shung Wu	17B	343	3	342	2	685	41	9	1
30020	PHI	Earl Benjamin Yap	21C	339	4	345	1	684	40	10	2
30003	SIN	Leow Ting Hao	19A	346	2	335	7	681	38	12	3
30007	THA	THONGWATTANA CHAKRIT	23A	346	1	332	9	678	39	9	4
30014	TPE	Chi Kun Liu	21B	337	5	341	3	678	36	11	5
30013	TPE	Sen Ching Lee	20B	337	6	337	4	674	36	13	6
30012	TPE	Chih Hao Wang	19B	336	9	337	5	673	28	7	7
30004	SIN	Chua Boon Rong, Adriel	20A	337	7	336	6	673	27	5	8
30001	SIN	Ong Chong Soon, Michael	17A	336	8	333	8	669	27	9	9
30018	PHI	Enrique Cojuangco Jr	19C	334	10	329	15	663	33	5	10
30005	INA	Gatot Ariyanto	21A	331	13	332	11	663	27	8	11
30011	TPE	Yung Ming Tsou	18B	333	11	329	13	662	27	7	12
30016	VIE	Nguyen Tien Cwng	17C	332	12	329	14	661	27	9	13
30008	THA	Pannoi Arkhom	24A	330	14	330	12	660	23	8	14
30009	THA	Fakkeaw Siripong	25A	326	17	332	9	658	25	8	15
30002	SIN	Heng Fook Hup, Vinson	18A	330	14	324	18	654	24	7	16
30015	TPE	Chih Ting Hsu	22B	325	18	325	17	650	23	9	17
30019	PHI	Rosendo Sombrio	20C	330	16	316	20	646	20	1	18
30006	INA	Wahyu Hidayat	22A	317	20	326	16	643	20	7	19
30023	HKG	ViSion Young	23B	311	22	319	19	630	17	7	20
30024	HKG	Tai Hoi Bun	24B	314	21	314	21	628	15	3	21
30017	VIE	Nguyen Thanh Tuan	18C	321	19	302	23	623	18	6	22
30025	HKG	Liu Ching Chung	25B	303	23	307	22	610	13	3	23
30021	PHI	Rosouro Timoko Bismark	22C	301	24	297	24	598	10	4	24



Judge *Jubh.*

Competition Dir *Mr. Sheng-chuan*

Scoring Dir.



2007 2nd Asian Grand Prix 亞洲大獎賽										
Group	Compound Men		Qualification Round						Team Total	Team Rank
Target No.	Country	Name	70 M	70 M	Total	Rank				
17B	TPE	Wen Shiung Wu	343	342	685	1				
19B	TPE	Chih Hao Wang	336	337	673	7		2020	1	
18B	TPE	Yung Ming Tsou	333	329	662	12				
19A	SIN	Leow Ting Hao	346	335	681	3				
17A	SIN	Ong Chong Soon, Michael	336	333	669	9		2004	2	
18A	SIN	Heng Fook Hup, Vinson	330	324	654	16				
23A	THA	THONGWATTANA CHAKRIT	346	332	678	4				
24A	THA	Pannoi Arkhom	330	330	660	14		1996	3	
25A	THA	Fakkeaw Siripong	326	332	658	15				
19C	PHI	Enrique Cojuangco Jr	334	329	663	10				
20C	PHI	Rosendo Sombrio	330	316	646	18		1907	4	
22C	PHI	Rosouro Timoko Bismark	301	297	598	24				
23B	HKG	ViSion Young	311	319	630	20				
24B	HKG	Tai Hoi Bun	314	314	628	21		1868	5	
25B	HKG	Liu Ching Chung	303	307	610	23				

Judge *[Signature]* Competition Dir. *[Signature]* Scoring Dir. *[Signature]*

# 2007 2nd Asian Prix Round

## Compound Men

Rank	Country	Name	Score
1	TPE	Wen Shiang Wu Chih Hao Wang Yung Ming Tsou	219
2	THA	THONGWATTANA CHAKRIT Pannoi Arkhom Fakkeaw Siripong	205
3	SIN	Leow Ting Hao Ong Cheng Soon, Michael Heng Fook Hup, Vinson	226

Target No.

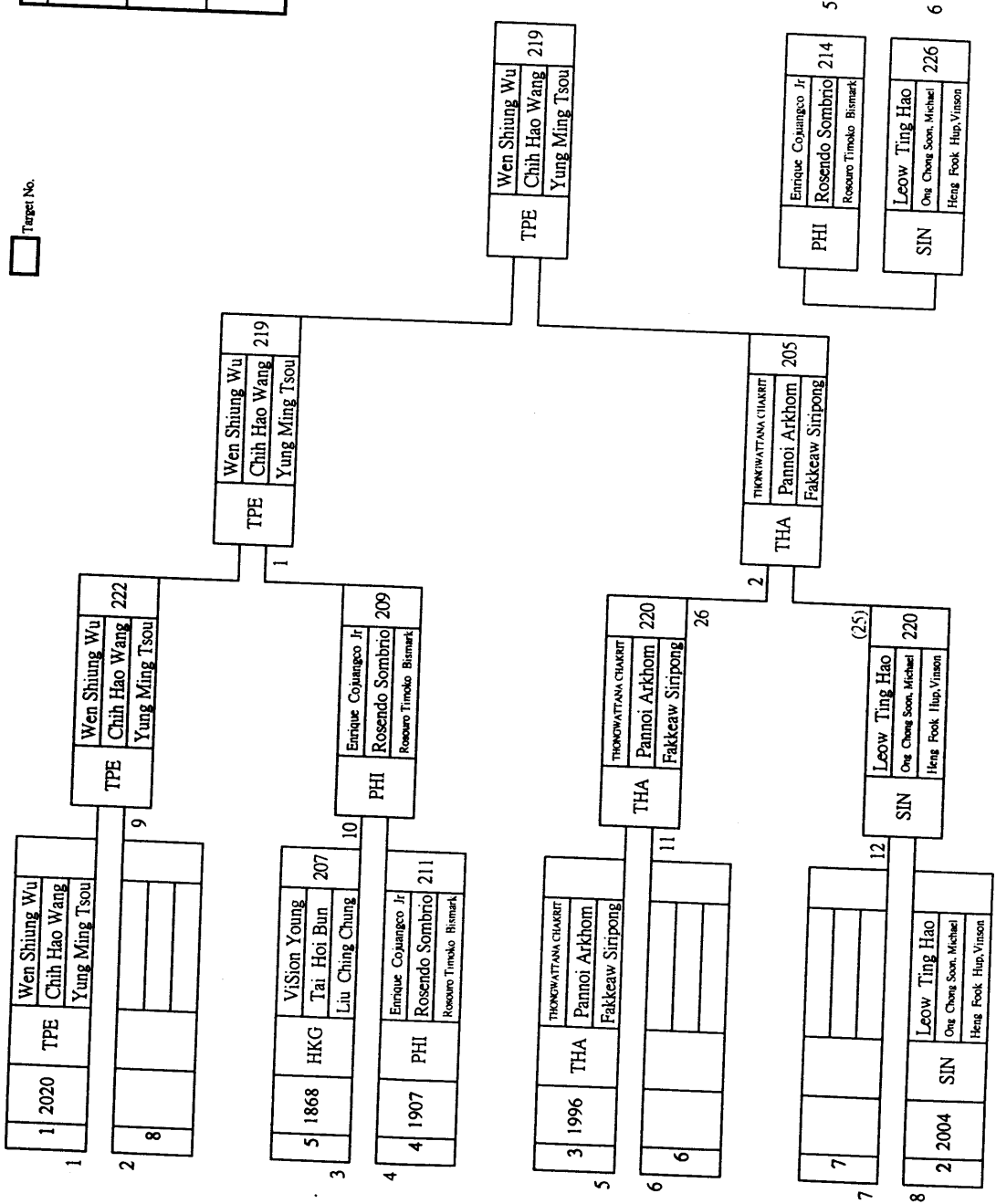

Judge John Sheng-chuan Competition Dir. [Signature] Scoring Dir. [Signature]



## 2007 2nd Asian Grand Prix 亞洲大獎賽

Compound Women			Qualification Round					Elimination & Final Round					
Rank	ID No.	Country	Name	Round 1 70 M	Round 2 70M	Total	10	X"	[1/16]	[1/8]	[1/4]	[1/2]	[Final]
1	70006	PHI	Ma Amaga Amparo R.Paz	340	325	665	39	12	0	114	107	110	112
2	70001	THA	Tinbua Narisara	340	330	670	32	10	0	113	109	110	108
3	70003	INA	Rona Siska Sari	319	329	648	18	2	0	106	104	103	107
4	70015	MAS	Siti Aisah Bt. Sudin	325	331	656	25	6	0	101	111	106	103
5	70005	VIE	Tran Nguyen Tieu Anh	315	323	638	20	6	0	101	106		
6	70012	TPE	Hui Tzu Liu	332	328	660	28	5	0	106	104		
7	70017	MAS	Khairiah Bt. Abd Halim	312	308	620	14	3	0	99	104		
8	70007	SIN	Lee Bee Teng,Shirlene	326	314	640	21	8	0	106	97		
9	70016	MAS	Norizah Bt. Ishak	307	304	611	6	2	0	108			
10	70014	TPE	Hui Chun Lin	298	303	601	13	3	94	105			
11	70008	SIN	Wong Lian Hoe,Jessie	326	306	632	19	7	0	104			
12	70013	TPE	Hsia Cheng Chang	320	313	633	22	8	0	102			
13	70004	HKG	Mun Yee Tang	311	306	617	14	4	0	97			
14	70011	SIN	Tan Ken Li	329	307	636	25	7	0	97			
15	70010	SIN	Leong Yoke Sim,Janie	306	308	614	11	1	0	93			
16	70009	SIN	Maryanne Gul	320	332	652	24	8	0	88			
17	70002	THA	Sapsanyakorn Preeyaporn	275	294	569	12	4	92				

# 2007 2nd Asian Grand Prix 亞洲大獎賽

## Compound Women

ID No.	Country	Name	Target No	Round 1 70 M	Rank	Round 2 70M	Rank	Total	10	X"	Rank
70001	THA	Tinbua Narisara	21A	340	1	330	3	670	32	10	1
70006	PHI	Ma Amaga Amparo R.Paz	26A	340	2	325	6	665	39	12	2
70012	TPE	Hui Tzu Liu	21C	332	3	328	5	660	28	5	3
70015	MAS	Siti Aisah Bt. Sudin	24C	325	7	331	2	656	25	6	4
70009	SIN	Maryanne Gul	23B	320	9	332	1	652	24	8	5
70003	INA	Rona Siska Sari	23A	319	10	329	4	648	18	2	6
70007	SIN	Lee Bee Teng,Shirlene	21B	326	5	314	8	640	21	8	7
70005	VIE	Tran Nguyen Tieu Anh	25A	315	11	323	7	638	20	6	8
70011	SIN	Tan Ken Li	25B	329	4	307	12	636	25	7	9
70013	TPE	Hsia Cheng Chang	22C	320	8	313	9	633	22	8	10
70008	SIN	Wong Lian Hoe,Jessie	22B	326	6	306	13	632	19	7	11
70017	MAS	Khairiah Bt. Abd Halim	26B	312	12	308	10	620	14	3	12
70004	HKG	Mun Yee Tang	24A	311	13	306	14	617	14	4	13
70010	SIN	Leong Yoke Sim,Janie	24B	306	15	308	10	614	11	1	14
70016	MAS	Norizah Bt. Ishak	25C	307	14	304	15	611	6	2	15
70014	TPE	Hui Chun Lin	23C	298	16	303	16	601	13	3	16
70002	THA	Sapsanyakorn Preeyaporn	22A	275	17	294	17	569	12	4	17

Judge Juli

Tsu Sheng-chien Scoring Dir.

[Signature]

Competition Dir.

# 2007 2<sup>nd</sup> Asian Prix Round

Compound Women

Rank	Country	Name	Total
1	PHI	Ma Amaga Amparo R.Paz	112
2	THA	Tinbua Narisara	108
3	INA	Rona Siska Sari	107
4	MAS	Siti Aisah Bt. Sudini	103

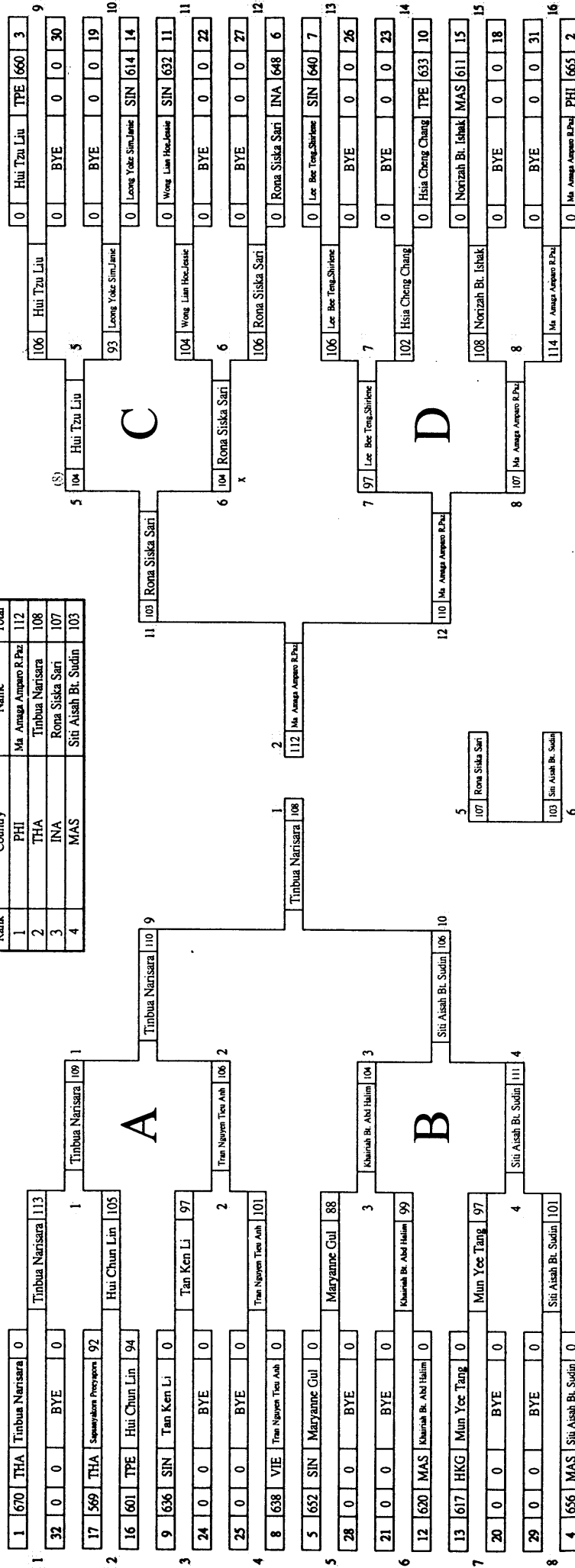

Judge: *Adnan* Competition Dir: *The Sheng-chien* Scoring Dir: *添成*

# 2007 2nd Asian Prix Round

## Compound Women

Target No.

Rank	Country	Name	Score
1	TPE	Hui Tzu Liu	213
		Hsia Cheng Chang	
		Hui Chun Lin	
2	SIN	Maryanne Gul	202
		Lee Bee Teng, Shirlene	
		Wong Lian Hoe, Jessie	
3	MAS	Siti Aisah Bt. Sudin	187
		Khairiah Bt. Abd Halim	
		Norizah Bt. Ishak	
		Norizah Bt. Ishak	

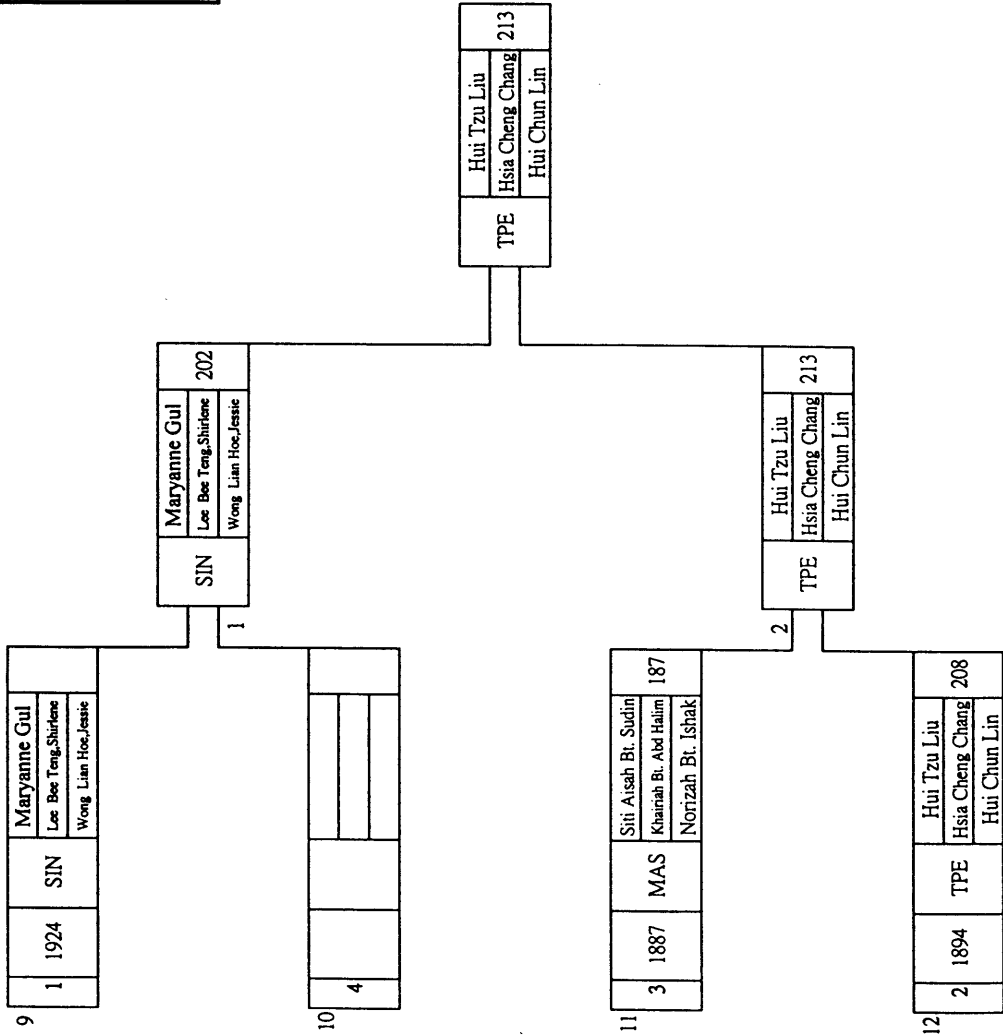

Judge *[Signature]* Competition Dir. *[Signature]* Scoring Dir. *[Signature]*

2007 2nd Asian Grand Prix 亞洲大獎賽										
Group	Compound Women		Qualification Round						Team Total	Team Rank
Target No.	Country	Name	70 M	70 M	Total	Rank				
23B	SIN	Maryanne Gul	320	332	652	5			1924	1
21B	SIN	Lee Bee Teng, Shirlene	326	314	640	7				
22B	SIN	Wong Lian Hoe, Jessie	326	306	632	11				
21C	TPE	Hui Tzu Liu	332	328	660	3			1894	2
22C	TPE	Hsia Cheng Chang	320	313	633	10				
23C	TPE	Hui Chun Lin	298	303	601	16				
24C	MAS	Siti Aisah Bt. Sudin	325	331	656	4			1887	3
26B	MAS	Khairiah Bt. Abd Halim	312	308	620	12				
25C	MAS	Norizah Bt. Ishak	307	304	611	15				

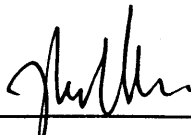
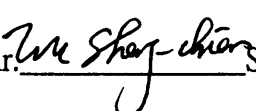
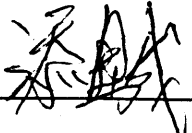
Judge  Competition Dir.  Scoring Dir. 

## 2007 2nd Asian Grand Prix 亞洲大獎賽

Recurve Men			Qualification Round					Elimination & Final Round					
Rank	ID No.	Country	Name	Round 1 70 M	Round 2 70M	Total	10	X*	[1/16]	[1/8]	[1/4]	[1/2]	[Final]
1	50015	TPE	Cheng Wei Kuo	341	331	672	33	9	114	114	114	113	110
2	50012	KOR	Jaekuk Ahn	330	334	664	30	4	116	110	111	107	104
3	50016	TPE	Cheng Pang Wang	341	334	675	40	16	115	109	114	110	113
4	50028	AUS	Cuddihy Timothy	330	324	654	22	2	107	110	109	106	102
5	50027	AUS	Ha Neul Kim	325	323	648	27	8	108	112	110		
6	50014	KOR	Hee Jae Park	335	344	679	39	15	119	113	106		
7	50018	TPE	Chih Lung Yu	324	322	646	23	4	102	108	102		
8	50005	JPN	Usui Tatsuro	315	315	630	16	5	105	112	100		
9	50017	TPE	Ming Huang Liu	338	321	659	29	10	111	109			
10	50019	TPE	Szu Yuan Chen	332	325	657	26	3	108	107			
11	50001	THA	THEPNA Detchai	327	315	642	22	8	110	107			
12	50011	KOR	Jong Geon Kim	327	333	660	31	10	115	106			
13	50013	KOR	Si Hyeon Jang	330	334	664	31	8	106	105			
14	50030	AUS	Cheah Ricci	319	318	637	15	5	103	103			
15	50004	JPN	Banno Taichi	318	327	645	23	7	110	103			
16	50029	AUS	Iyack Ryan	308	319	627	15	4	104	99			
17	50007	JPN	Oshima Jun	321	321	642	16	5	107				
18	50021	INA	Hendro Suprianto	312	302	614	14	1	106				
19	50006	JPN	Minoda Akihiro	331	304	635	25	6	106				
20	50031	SIN	Loh Wen Liang,Albert	324	321	645	25	7	104				
21	50022	INA	Mohammad Ali Sofian	323	323	646	15	4	104				
22	50023	HKG	Chan Kam Shing	305	309	614	12	1	103				
23	50024	HKG	Lee Kar Wai	309	302	611	13	3	101				
24	50020	TPE	Tzu Yi Hsu	327	316	643	21	3	101				
25	50003	THA	Inkaew Sakon	289	299	588	13	4	100				
26	50034	SIN	Ong Chee Tiong, Henry	295	288	583	10	4	100				
27	50026	HKG	Yip Sai Kit	305	280	585	11	1	100				
28	50025	HKG	Suen Tse Hin	292	305	597	10	4	99				
29	50002	THA	Thiangprasert Jarun	322	297	619	13	4	99				
30	50008	VIE	Nguyen Ba Hai	308	294	602	10	0	98				
31	50010	VIE	Nguyen Trong Nghiep	292	298	590	10	0	98				
32	50032	SIN	Ong Chee Bin, Benson	293	306	599	19	0	94				
33	50009	VIE	Pham Ngoc Hai	282	297	579	9	0					
34	50033	SIN	Pang Toh Jin	281	287	568	12	2					



# 2007 2nd Asian Grand Prix 亞洲大獎賽

Junior Recurve Men			Qualification Round					Elimination & Final Round					
Rank	ID No.	Country	Name	Round 1 70 M	Round 2 70M	Total	10	X"	[1/16]	[1/8]	[1/4]	[1/2]	[Final]
1	60018	TPE	Wei Che Chen	325	331	656	28	9	0	115	111	114	114
2	60020	IND	Rajib Basumatary	324	310	634	19	4	0	109	110	104	104
3	60021	IND	Prabhat Kandir	313	319	632	18	4	0	102	108	102	109
4	60017	TPE	I Cheng Weng	312	324	636	19	4	0	107	102	98	106
5	60019	IND	Raju Adonda	320	330	650	27	5	0	109	106		
6	60001	INA	Awal Ahmad	318	307	625	16	4	0	101	106		
7	60022	IND	Amardeep Kerketta	303	302	605	11	0	106	107	102		
8	60004	SIN	Tan Si Lie	315	290	605	17	3	92	105	98		
9	60011	MAS	Muhammad Izzuddin B Abdul Rahim	313	326	639	19	2	0	104			
10	60014	MAS	Md Hazlan Sali	302	307	609	13	0	101	103			
11	60016	TPE	Chia Chun Sung	322	316	638	16	2	0	101			
12	60015	TPE	Yen Ting Lin	312	308	620	15	3	0	101			
13	60012	MAS	Arif Farhan B Ibrahim Putra	305	306	611	7	2	0	99			
14	60002	INA	Riau Agata	302	313	615	13	2	0	99			
15	60013	MAS	Liew Tek Wa	299	297	596	12	5	94	95			
16	60007	HKG	Chan Ping Fan	300	270	570	6	3	92	93			
17	60003	SIN	Yeo Zhiren, Wilson	288	286	574	11	2	90				
18	60005	SIN	Abdud Dayyan Jaffar	311	286	597	15	2	86				
19	60008	HKG	Cheung Yuk Kei	247	233	480	2	0	76				
20	60010	HKG	Liu Chi Yuk	233	227	460	5	2	74				
21	60009	HKG	Chiu Tik Wai	260	260	520	5	3	64				
22	60006	AUS	Worth Taylor	0	306	306	5	1	0				

# 2007 2nd Asian Grand Prix 亞洲大獎賽

## Junior Recurve Men

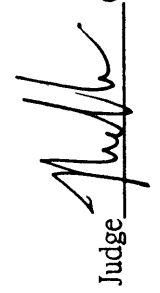
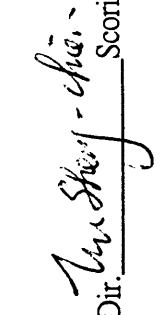
ID No.	Country	Name	Target No.	Round 1 70 M	Rank	Round 2 70M	Rank	Total	10	X"	Rank
60018	TPE	Wei Che Chen	16C	325	1	331	1	656	28	9	1
60019	IND	Raju Adonda	17C	320	4	330	2	650	27	5	2
60011	MAS	Muhammad Izzuddin B Abdul Rahim	17B	313	8	326	3	639	19	2	3
60016	TPE	Chia Chun Sung	14C	322	3	316	6	638	16	2	4
60017	TPE	I Cheng Weng	15C	312	9	324	4	636	19	4	5
60020	IND	Rajib Basumatary	18C	324	2	310	8	634	19	4	6
60021	IND	Prabhat Kandir	19A	313	7	319	5	632	18	4	7
60001	INA	Awal Ahmad	13A	318	5	307	10	625	16	4	8
60015	TPE	Yen Ting Lin	13C	312	9	308	9	620	15	3	9
60002	INA	Riau Agata	14A	302	14	313	7	615	13	2	10
60012	MAS	Arif Farhan B Ibrahim Putra	18B	305	12	306	13	611	7	2	11
60014	MAS	Md Hazlan Sali	20B	302	14	307	11	609	13	0	12
60004	SIN	Tan Si Lie	16A	315	6	290	16	605	17	3	13
60022	IND	Amardeep Kerketta	20A	303	13	302	14	605	11	0	14
60005	SIN	Abdud Dayyan Jaffar	17A	311	11	286	17	597	15	2	15
60013	MAS	Liew Tek Wa	19B	299	17	297	15	596	12	5	16
60003	SIN	Yeo Zhiren, Wilson	15A	288	18	286	17	574	11	2	17
60007	HKG	Chan Ping Fan	13B	300	16	270	19	570	6	3	18
60009	HKG	Chiu Tik Wai	15B	260	19	260	20	520	5	3	19
60008	HKG	Cheung Yuk Kei	14B	247	20	233	21	480	2	0	20
60010	HKG	Liu Chi Yuk	16B	233	21	227	22	460	5	2	21
60006	AUS	Worth Taylor	18A	0	22	306	12	306	5	1	22

Judge  Competition Dir.  Scoring Dir. 







2007 2nd Asian Grand Prix 亞洲大獎賽										
Group	Junior Recurve Men		Qualification Round						Team Total	Team Rank
Target No.	Country	Name	70 M	70 M	Total	Rank				
17C	IND	Raju Adonda	320	330	650	2			1916	1
18C	IND	Rajib Basumatary	324	310	634	6				
19A	IND	Prabhat Kandir	313	319	632	7				
16C	TPE	Wei Che Chen	325	331	656	1			1914	2
14C	TPE	Chia Chun Sung	322	316	638	4				
13C	TPE	Yen Ting Lin	312	308	620	9				
17B	MAS	Muhammad Izzuddin B Abdul Rahim	313	326	639	3			1846	3
18B	MAS	Arif Farhan B Ibrahim Putra	305	306	611	11				
19B	MAS	Liew Tek Wa	299	297	596	16				
16A	SIN	Tan Si Lie	315	290	605	13			1776	4
17A	SIN	Abdud Dayyan Jaffar	311	286	597	15				
15A	SIN	Yeo Zhiren, Wilson	288	286	574	17				
13B	HKG	Chan Ping Fan	300	270	570	18			1570	5
15B	HKG	Chiu Tik Wai	260	260	520	19				
14B	HKG	Cheung Yuk Kei.	247	233	480	20				

Judge gulli Competition Dir. Lee Sheng-chien Scoring Dir. 李成

# 2007 2nd Asian Grand Prix 亞洲大獎賽

Junior Recurve Women			Qualification Round					Elimination & Final Round					
Rank	ID No.	Country	Name	Round 1 70 M	Round 2 70M	Total	10	X"	[1/16]	[1/8]	[1/4]	[1/2]	[Final]
1	20011	TPE	Ying Ching Chen	327	284	611	17	5	0	96	94	104	105
2	20016	IND	Pranitha Vardhini	288	283	571	8	1	0	103	91	110	100
3	20012	TPE	Yue Shuan Lin	288	298	586	10	1	0	103	107	99	99
4	20013	TPE	Wan Ting Chang	310	281	591	13	1	0	97	104	92	97
5	20010	TPE	Chia Hung Chang	299	302	601	9	5	0	109	101		
6	20017	IND	Reshma Banerjee	300	289	589	9	2	0	94	94		
7	20014	IND	Nisha Rani Dutta	315	301	616	12	4	0	98	88		
8	20006	MAS	NUR AMIRAH BT MOHAMED	293	265	558	7	1	0	94	83		
9	20019	SIN	Wong Sok Wai,Samantha	285	277	562	7	3	0	103			
10	20020	SIN	Loh Tze Rong,Vanessa	279	197	476	8	0	0	95			
11	20008	MAS	NOR HUDA AZIDA BT ZOLKIFLI	291	281	572	9	1	0	94			
12	20004	HKG	Po Yin Chun	269	257	526	3	0	0	92			
13	20009	AUS	Gunawan Amie	266	246	512	4	1	0	90			
14	20018	SIN	Tan Kok Sim,Cindy	232	201	433	6	2	0	90			
15	20005	HKG	Wong Hei Man	232	140	372	1	0	81	84			
16	20015	IND	Rosie Lalremhluni	273	248	521	7	1	0	83			
17	20007	MAS	SHARFAH MADIAH BT SYED HOO	209	203	412	3	0	74				

# 2007 2nd Asian Grand Prix 亞洲大獎賽

## Junior Recurve Women

ID No.	Country	Name	Target No.	Round 1 70 M	Rank	Round 2 70M	Rank	Total	10	X	Rank
20014	IND	Nisha Rani Dutta	11B	315	2	301	2	616	12	4	1
20011	TPE	Ying Ching Chen	12A	327	1	284	5	611	17	5	2
20010	TPE	Chia Hung Chang	11A	299	5	302	1	601	9	5	3
20013	TPE	Wan Ting Chang	14A	310	3	281	7	591	13	1	4
20017	IND	Reshma Banerjee	14B	300	4	289	4	589	9	2	5
20012	TPE	Yue Shuan Lin	13A	288	9	298	3	586	10	1	6
20008	MAS	NOR HUDA AZIDA BT ZOLKIFLI	16B	291	7	281	8	572	9	1	7
20016	IND	Pranitha Vardhini	13B	288	8	283	6	571	8	1	8
20019	SIN	Wong Sok Wai, Samantha	12C	285	10	277	9	562	7	3	9
20006	MAS	NUR AMIRAH BT MOHAMED	14C	293	6	265	10	558	7	1	10
20004	HKG	Po Yin Chun	15A	269	13	257	11	526	3	0	11
20015	IND	Rosie Lalremhluni	12B	273	12	248	12	521	7	1	12
20009	AUS	Gunawan Amie	15C	266	14	246	13	512	4	1	13
20020	SIN	Loh Tze Rong, Vanessa	13C	279	11	197	16	476	8	0	14
20018	SIN	Tan Kok Sim, Cindy	11C	232	15	201	15	433	6	2	15
20007	MAS	HARFAH MADIAH BT SYED HOO	15B	209	17	203	14	412	3	0	16
20005	HKG	Wong Hei Man	16A	232	16	140	17	372	1	0	17



Head Judge Juli Competition Dir. Mu Sheng-chow Scoring Dir. \_\_\_\_\_



2007 2nd Asian Grand Prix 亞洲大獎賽										
Group	Junior Recurve Women		Qualification Round						Team Total	Team Rank
Target No.	Country	Name	70 M	70 M	Total	Rank				
12A	TPE	Ying Ching Chen	327	284	611	2			1803	1
11A	TPE	Chia Hung Chang	299	302	601	3				
14A	TPE	Wan Ting Chang	310	281	591	4				
11B	IND	Nisha Rani Dutta	315	301	616	1			1708	2
13B	IND	Pranitha Vardhini	288	283	571	8				
12B	IND	Rosie Lalremhluni	273	248	521	12				
16B	MAS	NOR HUDA AZIDA BT ZOLKIFLI	291	281	572	7			1542	3
14C	MAS	NUR AMIRAH BT MOHAMED	293	265	558	10				
15B	MAS	SHARFAH MADIAH BT SYED HOOD	209	203	412	16				
12C	SIN	Wong Sok Wai, Samantha	285	277	562	9			1471	4
13C	SIN	Loh Tze Rong, Vanessa	279	197	476	14				
11C	SIN	Tan Kok Sim, Cindy	232	201	433	15				

Judge Jullis Competition Dir. Man Siong Chiew Scoring Dir. Man Siong Chiew

# 2007 2nd Asian Prix Round

## Junior Recurve Women

Target No.

Rank	Country	Name	Score
1	TPE	Ying Ching Chen Chia Hung Chang Wan Ting Chang	206
2	IND	Nisha Rani Dutta Pranitha Vardhini Rosie Lalremhlumi	184
3	SIN	Wong Sok Wai, Samantha Loh Tze Rong, Vanessa Tan Kok Sim, Cindy	186

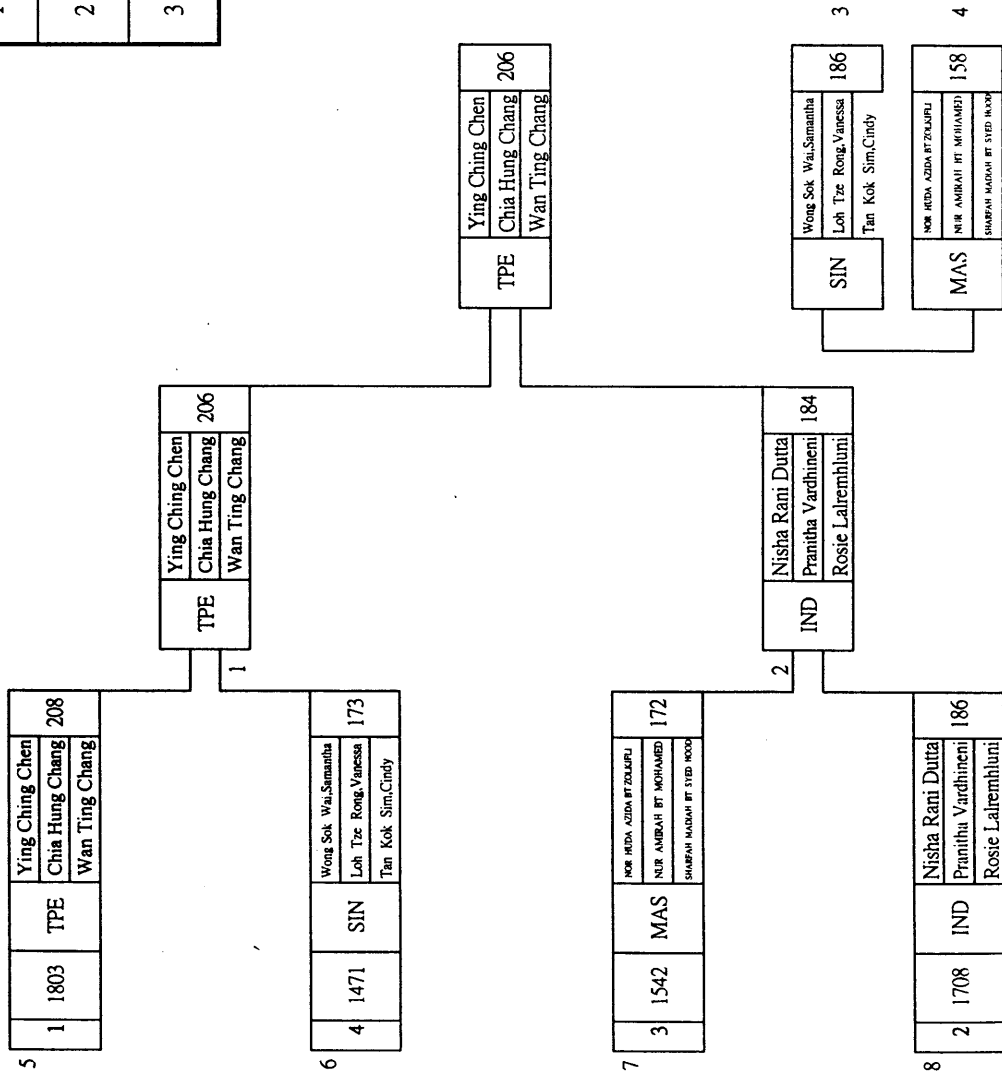

Judge John Seng-dian Competition Dir. [Signature] Scoring Dir. [Signature]



## 2007 2nd Asian Grand Prix 亞洲大獎賽

<i>Junior Compound Men</i>			Qualification Round					Elimination & Final Round			
Rank	ID No.	Country	Name	Round 1 70 M	Round 2 70M	Total	10	X"	[1/4]	[1/2]	[Final]
1	40005	IND	Abhishek Verma	335	334	669	33	10	107	114	109
2	40004	HKG	Chan Pak Ki	308	293	601	13	1	112	107	104
3	40007	IND	Sumit Kumar Mishra	321	324	645	21	5	112	106	107
4	40006	IND	Sonam Pinto Lepcha	314	295	609	11	4	105	103	105
5	40002	HKG	Yip Man Chun	316	306	622	18	4	106		
6	40003	HKG	Pang King Hang	307	280	587	9	1	105		
7	40001	HKG	Chan Kin Wai	305	299	604	11	1	99		
8	40008	IND	Bikash Gurung	310	278	588	23	3	98		

# 2007 2nd Asian Grand Prix 亞洲大獎賽

## Junior Compound Men

ID No.	Country	Name	Target No.	Round 1 70 M	Rank	Round 2 70M	Rank	Total	10	X	Rank
40005	IND	Abhishek Verma	27B	335	1	334	1	669	33	10	1
40007	IND	Sumit Kumar Mishra	26C	321	2	324	2	645	21	5	2
40002	HKG	Yip Man Chun	27A	316	3	306	3	622	18	4	3
40006	IND	Sonam Pinto Lepcha	28B	314	4	295	5	609	11	4	4
40001	HKG	Chan Kin Wai	26A	305	8	299	4	604	11	1	5
40004	HKG	Chan Pak Ki	26B	308	6	293	6	601	13	1	6
40008	IND	Bikash Gurung	27C	310	5	278	8	588	23	3	7
40003	HKG	Pang King Hang	28A	307	7	280	7	587	9	1	8



Judge Juh Competition Dir. Zee Sheng-Chian Scoring Dir. \_\_\_\_\_